

REV.	DESCRIPTION	DATE
A	NEW DRAWING	7/30/2007

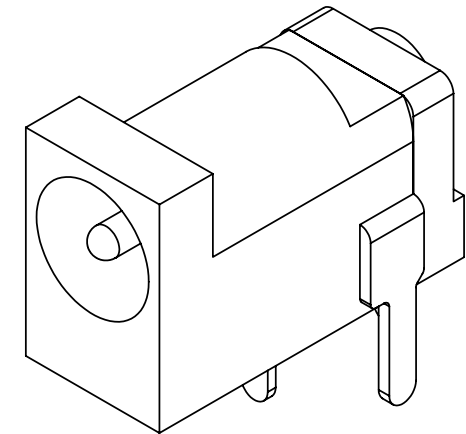

TOLERANCE:
 X.X±0.2mm
 X.XX±0.1mm
 X.XXX±0.05mm

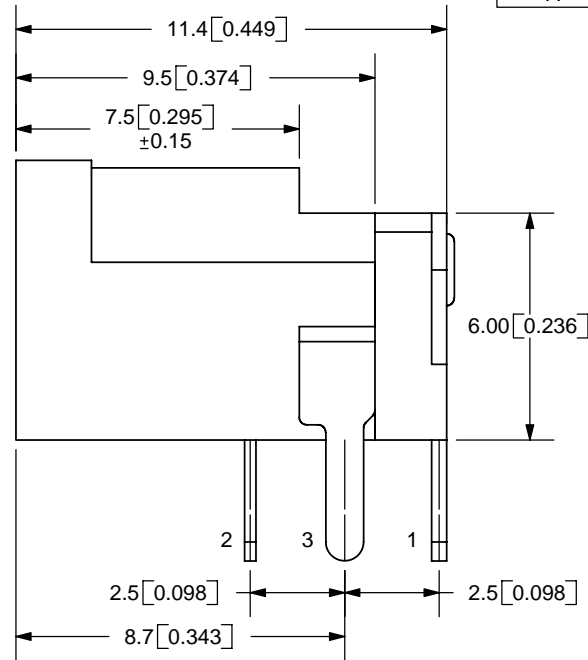
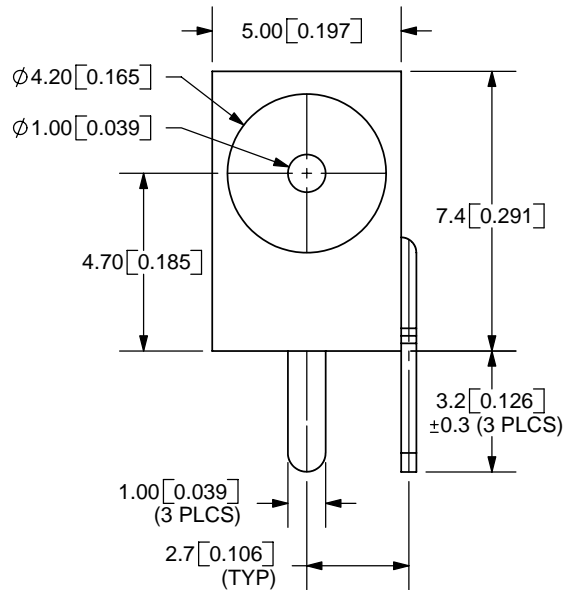
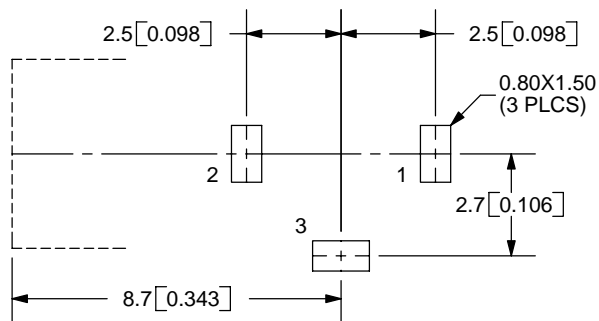

PCB LAYOUT
TOP VIEW

SPECIFICATIONS:
 RATING: 16V DC @ 2A
 CONTACT RESISTANCE: 50m OHMS MAX
 INSULATION RESISTANCE: 100M OHMS MIN: 500V DC
 VOLTAGE WITHSTAND: 500V AC R.M.S. FOR 1 MINUTE
 LIFE: 5,000 CYCLES

MODEL NO.	PJ-031C
SCHEMATIC	

CENTER PIN DIAMETER 1.00mm Dia.

	MATERIAL	PLATING
CENTER PIN	Copper	Nickel
TERMINAL 1	Brass	Tin
TERMINAL 2	Copper Alloy	Tin
TERMINAL 3	Brass	Tin
BODY	PBT	



20050 SW 112th Ave.
 Tualatin, OR 97062
 Phone: 503-612-2300
 800-275-4899
 Fax: 503-612-2383
 Website: www.cui.com

TITLE: DC POWER JACK	REV: A
PART NO. PJ-031C	UNITS: MM [INCHES]
DRAWN BY: ZRJ	APPROVED BY:
	SCALE: 5:1

PC FILE NAME: PJ-031C

COPYRIGHT 2007 BY CUI INC.